

極数/CKT	製品番号/PARTS No.	A	B	C	D	E	F	G	H	NOTE
30	9827S-30Y915	12.85	16.6	21.4	28.4	32.0	14.2	26.0		
40	-40	16.85	20.6	25.4						
50	-50	20.85	24.6	29.4	40.4	44.0	20.2	37.0		
60	-60	24.85	28.6	33.4					80.0	
70	-70	28.85	32.6	37.4						
80	-80	32.85	36.6	41.4	52.4	56.0	26.2	49.0		
90	-90	36.85	40.6	45.4						
100	-100	40.85	44.6	49.4						
110	-110	44.85	48.6	53.4	68.4	72.0	34.2	65.0	100.0	
120	9827S-120Y915	48.85	52.6	57.4						

NOTE

- 梱包数量/UNIT QUANTITY: 500
- リードテープ長さ/LEAD TAPE LENGTH

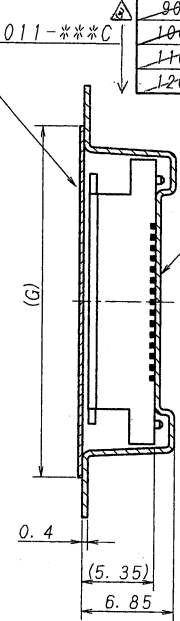
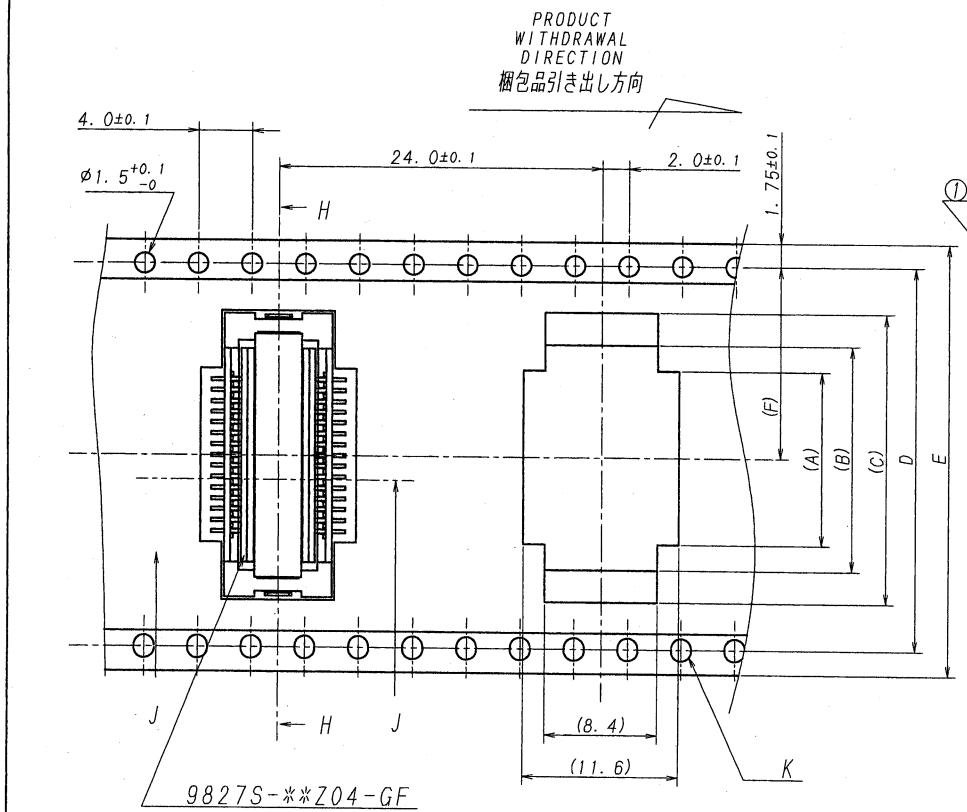

SECT. H-H

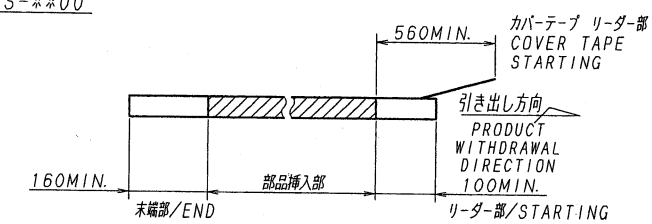

- カバーテープの剥離強度/COVER TAPE PEELING FORCE : 0.2N MIN.

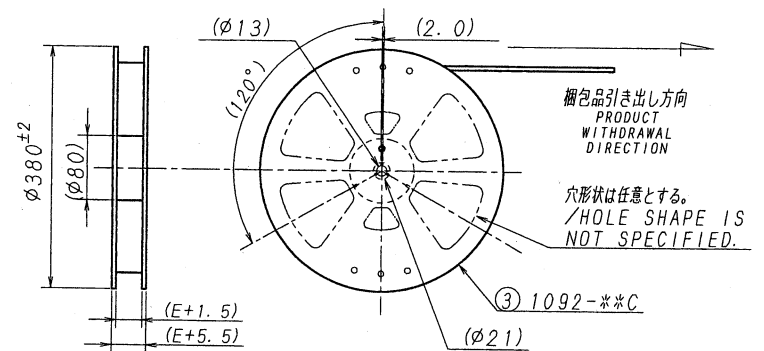
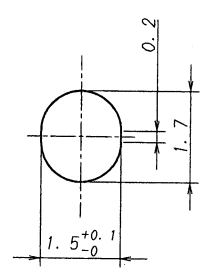
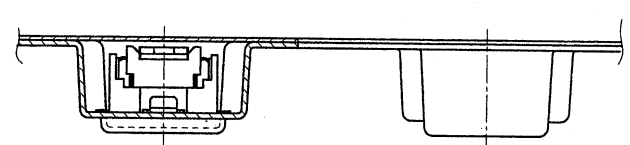
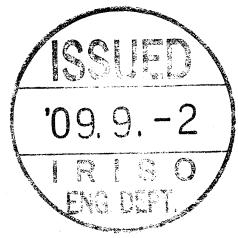
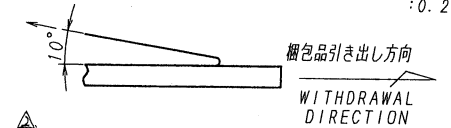

△						MATERIAL 材質	GENERAL TOLERANCES 一般公差	SCALE 尺度	UNIT 単位	TITLE 名称
△						① カバーテープ/COVER TAPE: PET TYPE ② キャリアテープ/CARRIER TAPE: A-PET ③ リール/REEL : PS 黒/BLACK	DIM 寸法 ± 0.3 ANGLE 角度 ±	DR 09 4/20 J. Oguro CHK 09-4-20 K. Sasaki	mm DSN 07 2/9 H. Shioda APP 09-4-20	9827シリーズ ソケットテーピング 梱包品 SERIES 9827 SOCKET TAPING PRODUCT
△						FINISH 仕上げ	3RD. ANG. PROJ. 三角法	IRISO ELECTRONICS CO., LTD. IRISO 電子工業株式会社		EDP No
△	35346	REVISED	JIN	M.T	09-4-20					PARTS No 部番
△	34497	REVISED	J	G.S	09-4-20					9827S-**Y915
LTR 記号	ECN No	REVISION RECORD 記号	DR	CHK	DATE 年月日					DWG No 図番
										1MSA-9827S-**Y915
										REV.

DO NOT SCALE DRAWING. THIS DRAWING CONTAINS INFORMATION THAT IS PROPRIETARY TO IRISO AND SHOULD NOT BE USED WITHOUT WRITTEN PERMISSION.

本図面は、IRISO電子工業株式会社の所有する権利を含有し、この図面の許可なく複製を禁止する。

REVISED COPY