

A B C D E F G H

板数/CKT	製品番号/PARTS No.	A	B	C	D	E	F	G
30	9860B-30Y900	13.0	16.7	28.4	32	14.2	26.0	80.0
40	9860B-40Y900	17.0	20.7	40.4	44	20.2	37.0	
50	9860B-50Y900	21.0	24.7					
60	9860B-60Y900	25.0	28.7	52.4	56	26.2	49.0	
70	9860B-70Y900	29.0	32.7					
80	9860B-80Y900	33.0	36.7	68.4	72	34.2	65.0	
90	9860B-90Y900	37.0	40.7					
100	9860B-100Y900	41.0	44.7	100.0	100.0	100.0		
110	9860B-110Y900	45.0	48.7					
120	9860B-120Y900	49.0	52.7					

PRODUCT WITHDRAWAL DIRECTION
梱包品引き出し方向

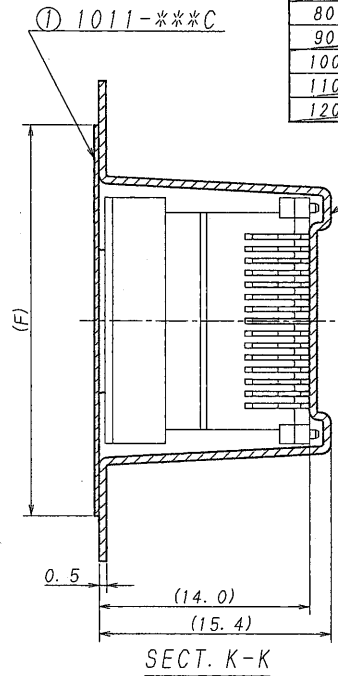
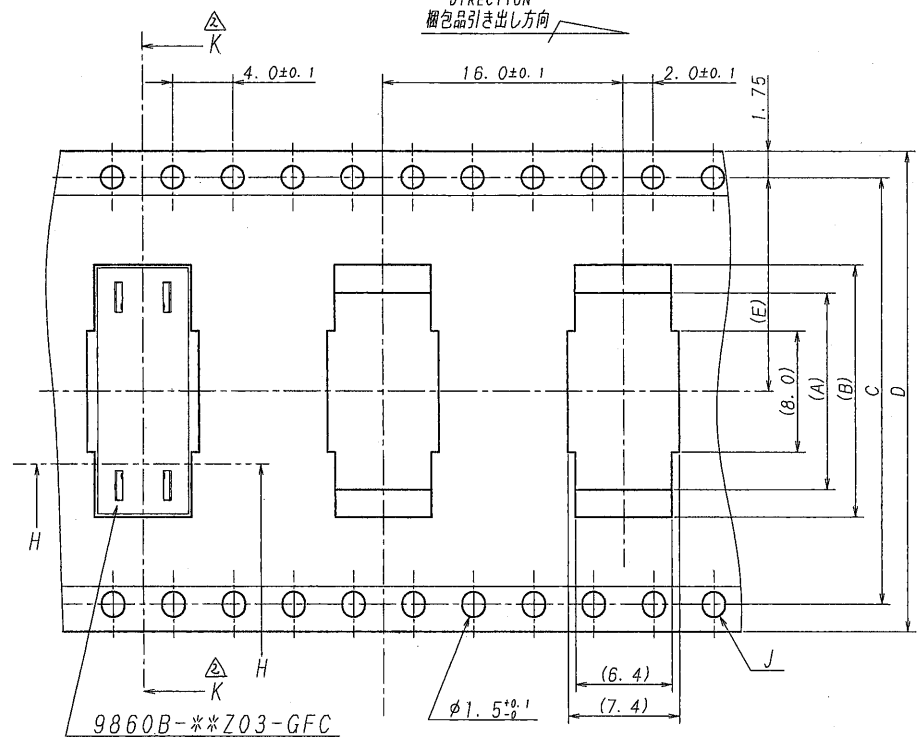

② 9860B-***00

- NOTE
1. 梱包数量/UNIT QUANTITY: 300
 2. リードテープ長さ/LEAD TAPE LENGTH

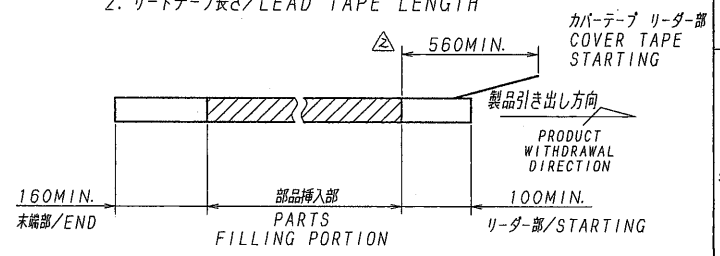

3. カバーテープの剥離強度/COVER TAPE PEELING FORCE : 0.2N MIN.

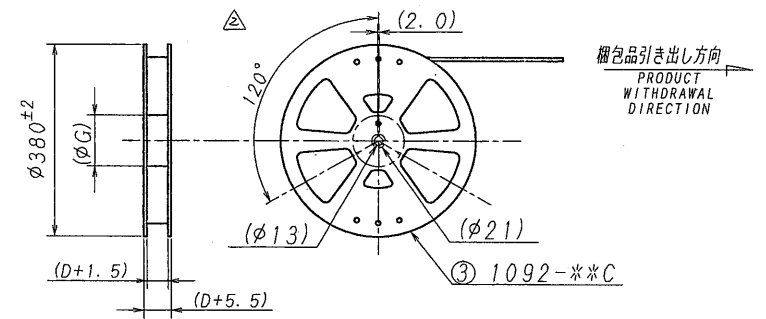
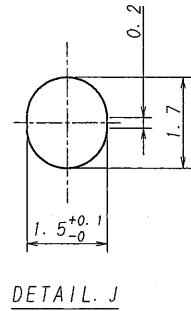
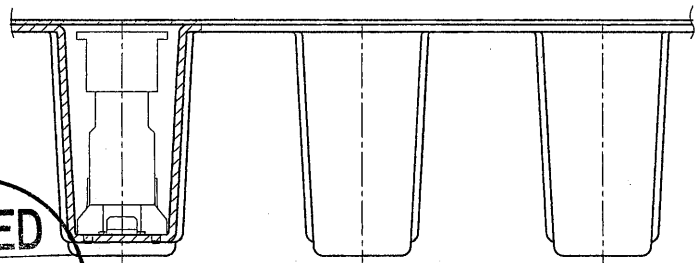
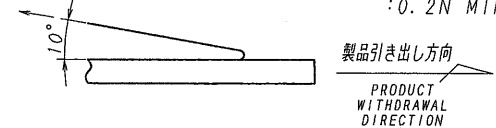

ISSUED
'07.4.05
IRISO
ENG. DEPT.

MATERIAL 材質				GENERAL TOLERANCES 一般公差		SCALE 尺度		UNIT 単位		TITLE 名称	
① カバ-テープ/COVER TAPE: PET TYPE				DIM 寸法 ± 0.3		/		mm		9860シリーズ プラグ テーピング梱包品	
② キャリアテープ/CARRIER TAPE: A-PET				ANGLE 角度 ±		DR 107		DSN 04		SERIES 9860 PLUG TAPING PRODUCT	
③ リール/REEL : PS (黒/BLACK)						3/9 S KASU		3/1 HONMA		EDP No	
FINISH 仕上げ				3RD. ANG. PROJ. 三角法		CHK 07-3-29		APP 07-4-4		PARTS No 部番	
						M. TAKASU		J. J. J.		9860B-***Y900	
28893 REVISED						IRISO ELECTRONICS CO., LTD.				DWG No 図番	
DR G.K. MT 3/29 '07						IIY電子工業株式会社				IMSA-9860B-***Y900	
LTR 記号 ECN NO REVISION RECORD 記号 DR CHK DATE 年月日										REV. 2	

DO NOT SCALE DRAWING.

IRISO ELECTRONICS CO., LTD.